

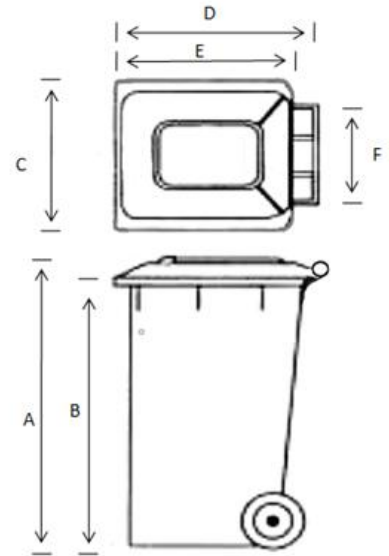

80 Litre MGB

QUALITY

- SAI Global Certified Product AS 4123 (SMK40411)
- SAI Global Recognised Laboratory AS4123.5 (40119)
- ISO 9001 Quality Management Systems
- ISO 14001 Environmental management Systems
- Injection Moulded HDPE
- UV Stabilized
- Chemical and odour resistant
- Heat and frost resistant
- Solid rubber tyre wheels (removable)
- Heavy duty nickel plated steel axle
- Maximum Nominal Load 32 kg
- Maximum Mass 41 kg



FLEXIBILITY

- Bin and Lid embossing
- Hot Stamping bin and lid
- RFID tags
- Thermal Printing options

Weight (approx) 7kg
Volume: 80 Litres
Wheel Diameter: 200mm

A. 846mm D. 508mm
B. 790mm E. 450mm
C. 448mm F. 310mm

COLOURS

- Bin Body: Dark Green, Nature Green and Black
- Wide range of lid colours to suit

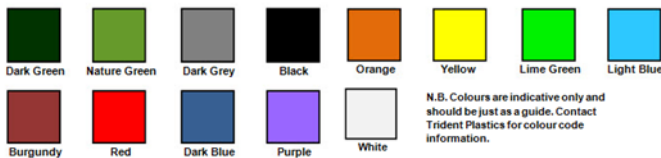

WARRANTY

- 10 Year manufacturing warranty*
- Subject to terms and conditions of sale.



Trident Plastics (SA) Pty Ltd
589 Torrens Road, St Clair South Australia 5011
www.tridentaustralia.com

E: bins@tridentaustralia.com Ph: +61 8 8444 6200

